

STRUCTURAL STEEL

WIDE FLANGE

6 x 4 x 9#
8 x 4 x 10#
8 x 4 x 15#
10 x 4 x 12#
12 x 4 x 16#

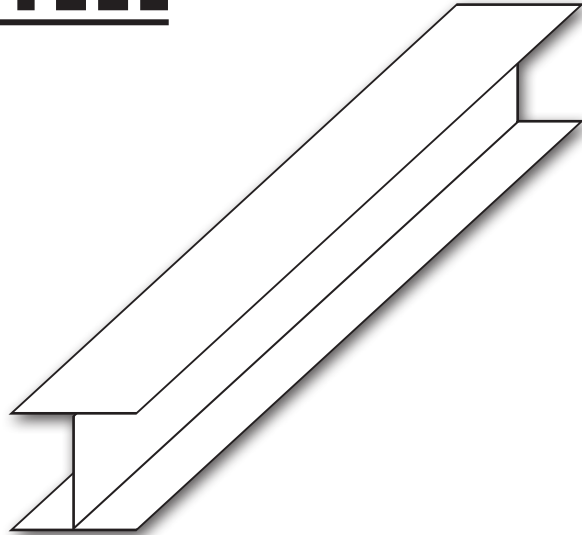

TUBING

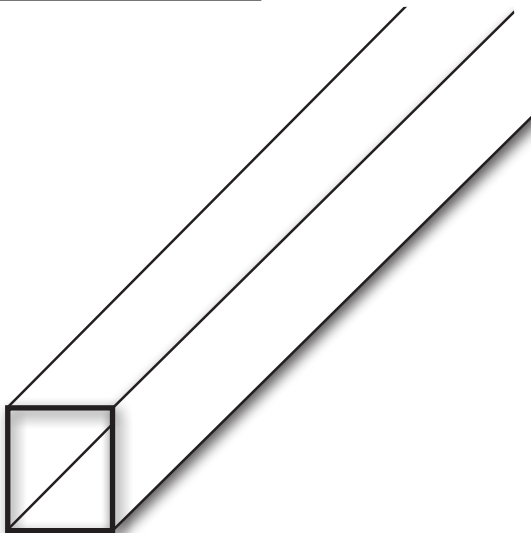

1 1/2 x 3 x 14 GA 24
3 x 3 x 14 GA 24
2 1/2 x 2 1/2 x 14 GA 20
3 x 3 x 11 GA 24
4 x 4 x 11 GA 24

Pipe

2 3/8 sch 40
4 1/2 sch 40
5 1/2 sch 40

"C" PERLIN

PERLINS

| | |
|--------------------------|--------------------|
| 3 X 1 1/2 X 14 GA | 20 & 30 |
| 4 X 1 1/2 X 14 GA | 20, 25, 30 |
| 6 X 2 X 14 GA | 20, 25, 30 |
| 8 X 2 1/2 X 14 GA | 20, 25, 30 |

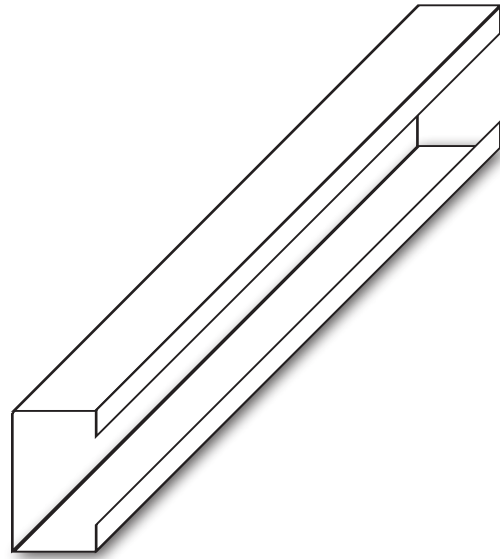

RECEIVER CHANNEL

| | |
|----------------------|-----------|
| 4 x 3 x 14 GA | 25 |
| 6 x 3 x 14 GA | 25 |
| 8 x 3 x 14 GA | 25 |

Purlin Clips

5 x 7 x 3/16
6 x 8 x 1/4

Anchor Plates

6 x 6
6 x 10

Weld Plate

6 x 6 x 3/8
6 x 10 x 3/8

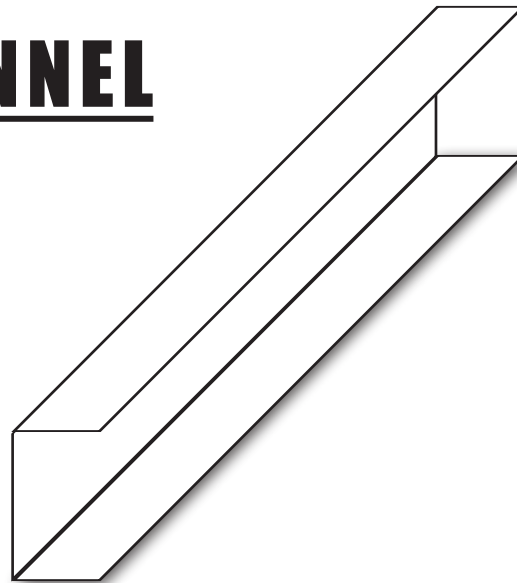

RAKE & BASE

ANGLE

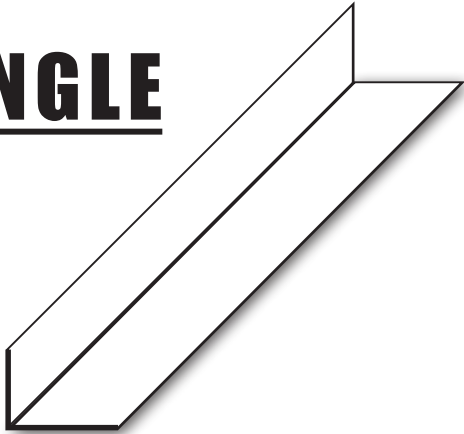

| | |
|----------------------|------------|
| 2 x 2 x 14 GA | 20' |
| 2 x 3 x 14 GA | 20' |
| 2 x 4 x 14 GA | 20' |

ANGLE IRON

| | |
|---------------------|------------|
| 2 x 2 x 1/8 | 20' |
| 2 x 3 x 3/16 | 20' |
| 3 x 3 x 1/4 | 20' |

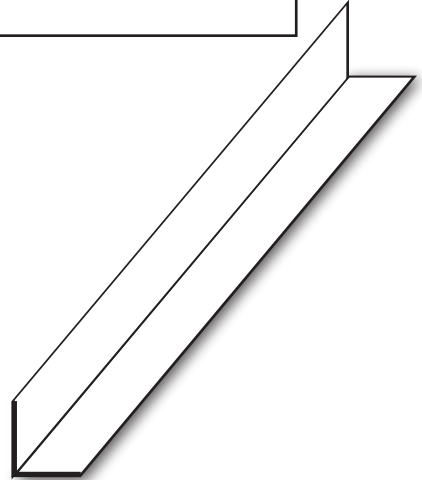

FLAT BAR & SHEETS

| |
|-------------------------|
| 4 x 1/4 x 20 |
| 5 x 3/16 x 20 |
| 6 x 1/4 x 20 |
| 6 x 1/2 x 20 |
| 4 x 10 x 10 GA |
| 4 x 10 x 3/16 GA |

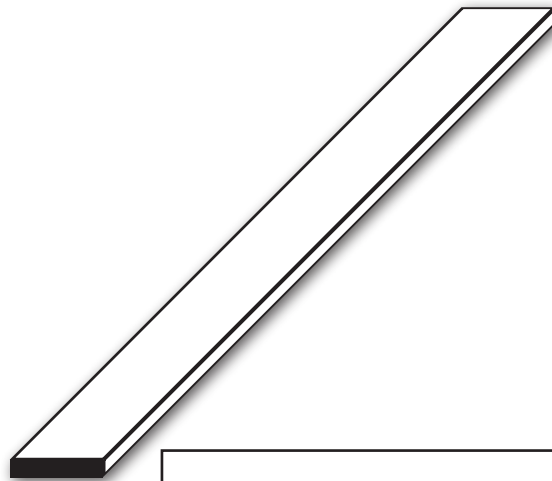

Rebar

| | |
|-------------------|-------------------------|
| 3/8" x 20' | 288 Full Bundles |
| 1/2" x 20' | 150 pcs. |

METAL BUILDING

ACCESSORIES

INSULATION

72" x 3" x 101' (Fiberglass)
48" x 3" x 101' (Fiberglass)
48" x 3" x 51' (Fiberglass)
72" x 3" x 31' (Fiberglass)
48" x 3" x 31' (Fiberglass)
72" x 1/4 x 125 (Solar Guard 2000)
6' x 300' Chicken Wire
Insulation Patch Tape
Doublesided Tape

CLOSURES &

SEALERS

Inside R Panel
Outside R Panel
Inside Low Rib Panel
Outside Low Rib Panel
1/2" x 3/32" x 45" Rope Sealer
Tube Caulking

SKYLIGHTS

| | | |
|---------------------|----------------|--------------|
| 3 x 10' - 8" | R Panel | Frost |
| 3 x 10' - 8" | Low Rib | Clear |

SCREWS

Driller Screws
#12 x 1 1/4

Laptek Screws
#12 x 7/8

Woodbinders
#10 x 1 1/2

Screws Bagged
In quantity of 250

All Screws are Stocked in our Standard Colors

POP RIVETS

1/8" Rivets

Pop Rivets Standard Colors

DRIVE PINS & NUTSETTERS

1/4" x 1 1/4" Drive Pins
1/4" Nutsetters
5/16" Nutsetters

DOORS

3070 Walk Door

with 8 1/4 Frame, Hinges, Lockset, Threshold

3070 Walk Door with Deadbolt Lock

with 8 1/4 Frame, Hinges, Deadbolt, Passage Knob, Threshold

4070 Walk Door with Deadbolt

with 8 1/4 Frame, Hinges, Deadbolt, Passage Knob & Threshold

10 x 10 Roll up Door

12 x 12 Roll up Door

Other Sizes Available upon Request.

MASTER FLASHING

3 (1/4 - 4")

5 (4 - 7")

6 (5 - 9")

**Cold Temp
High Temp**

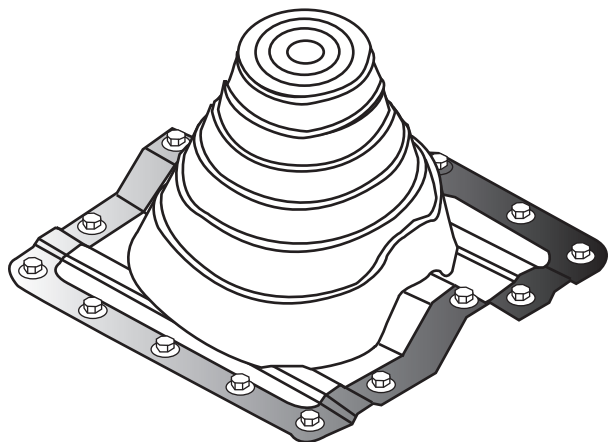

METAL STUDS & TRACK

TRACK

| | |
|---------------------|--------------|
| 3 5/8" x 10' | 24 GA |
| 3 5/8" x 10' | 18 GA |
| 5 5/8" x 10' | 18 GA |

STUDS

| | |
|----------------|--------------|
| 3 1/2 x | 24 GA |
| 3 1/2 x | 18 GA |
| 5 1/2 x | 24 GA |
| 5 1/2 x | 18 GA |

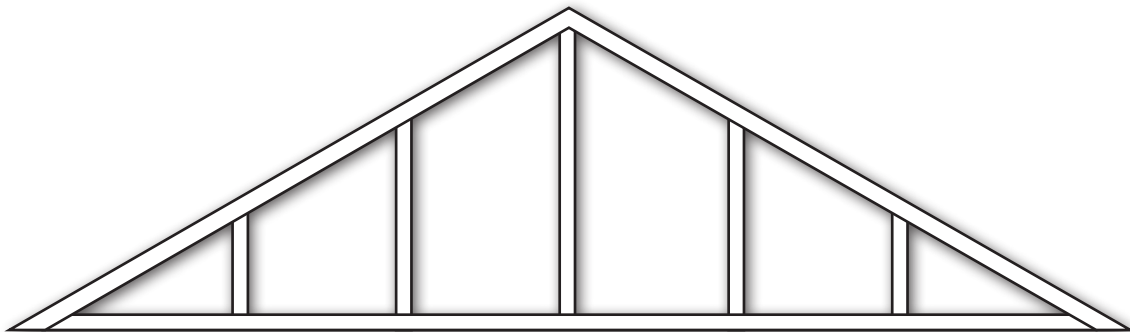
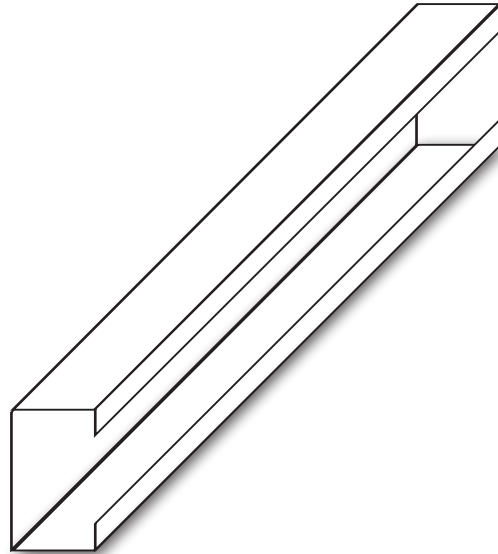

**Tube-Trusses Available up to 40' Wide
Standard 2:12 Roof Pitch
Trusses Also Made for All Steel Homes.**

TRIM FOR R-PANELS

Outside Corner

R-1

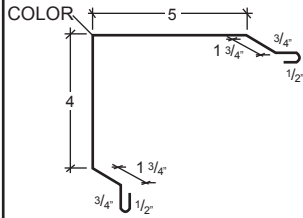

Downspouts

R-5

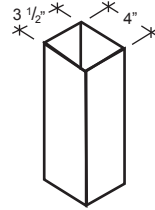

Inside Corner

R-2

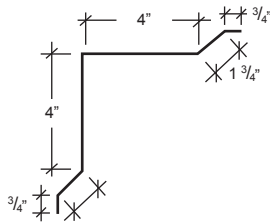

Downspouts with Kick Out

R-6

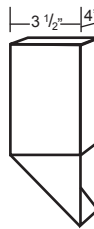

* Field Installed

Sculptured Rake

R-3

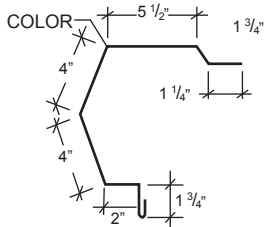

Sculptured Gutter Ends Left/Right Pitch

R-7

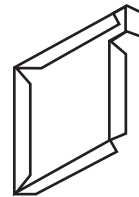

Sculptured Gutter

R-4

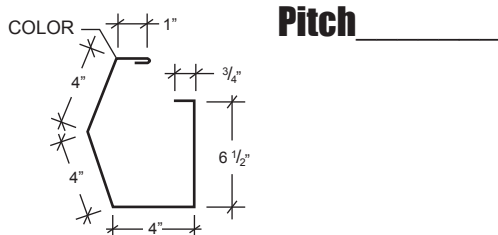

Gutter Straps

R-8

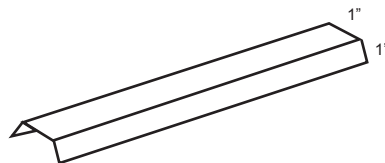

TRIM FOR R-PANELS

Flat Ridge

R-9

Pitch _____

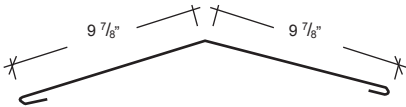

Ridge Roll

R-13

Pitch _____

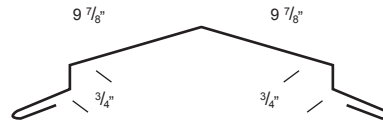

Jamb

R-10

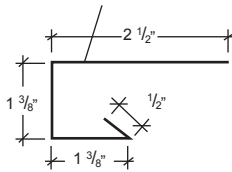

Rat Guard - R -

R-14

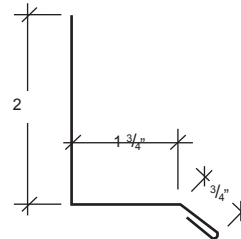

Header

R-11

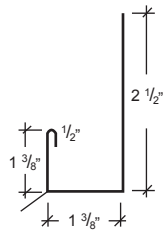

Wall Transition

R-15

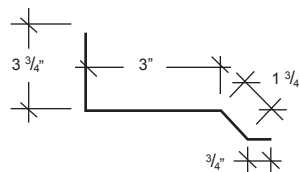

Cap

R-12

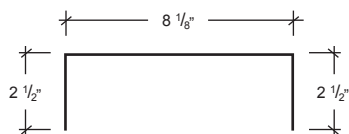

Roof Transition

R-16

Pitch _____

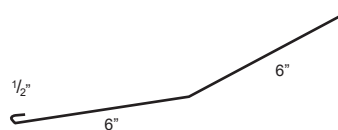

TRIM FOR R-PANELS

Valley

R-17

Pitch _____

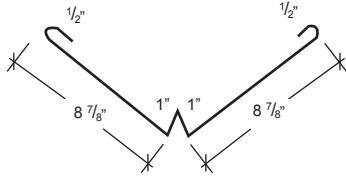

Outside Angle

R-21

Size _____

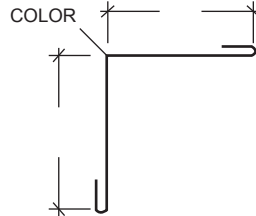

Pick Size
4" x 4" or
3" x 3"

Utility Eave

R-18

Pitch _____

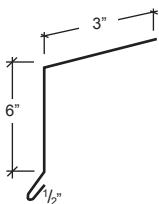

Inside Angle

R-22

Size _____

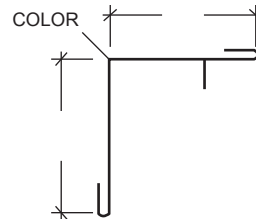

Pick Size
4" x 4" or
3" x 3"

Peak Boxes

R-19

Pitch _____

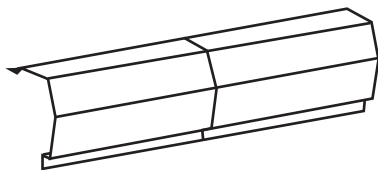

Corner Boxes

R-23

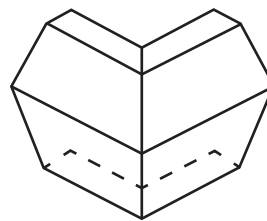

Hi - Side Eave

R-20

Pitch _____

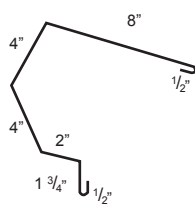

Downspout Straps

R-24

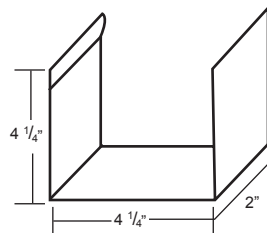

TRIM FOR TUFF RIB PANELS

Outside Corner

T-1

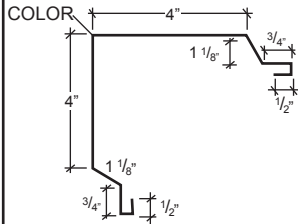

Downspouts

T-5

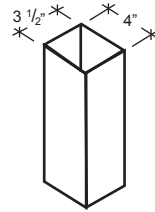

Inside Corner

T-2

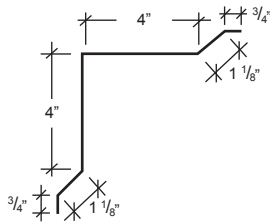

Downspouts with Kick Out

T-6



* Field Installed

Sculptured Rake

T-3

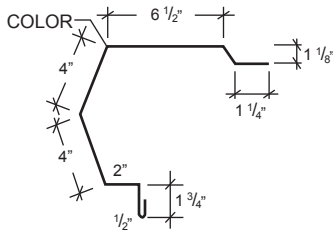

Sculptured Gutter Ends Left/Right Pitch

T-7

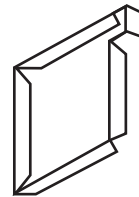

Sculptured Gutter

T-4

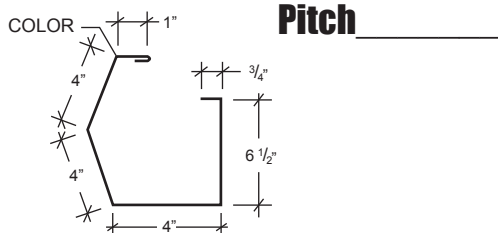

Gutter Straps

T-8

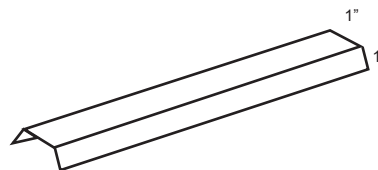

TRIM FOR TUFF RIB PANELS

Flat Ridge

T-9

Pitch _____

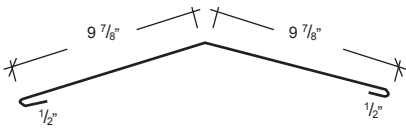

Ridge Roll

T-13

Pitch _____

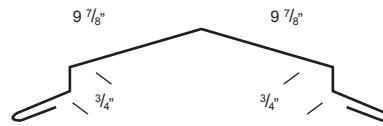

Jamb

T-10

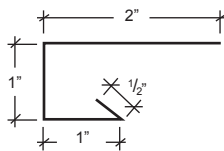

Rat Guard - R -

T-14

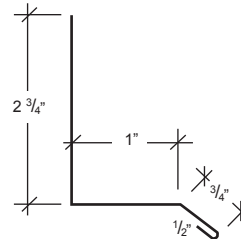

Header

T-11

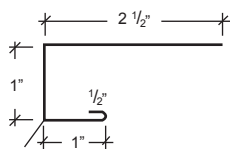

Wall Transition

T-15

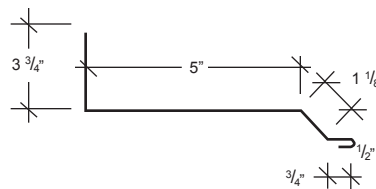

Cap

T-12

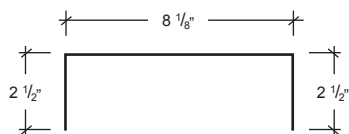

Roof Transition

T-16

Pitch _____

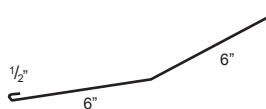

TRIM FOR TUFF RIB PANELS

Valley

T-17

Pitch _____

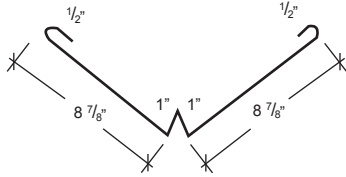

Outside Angle

T-21

Size _____

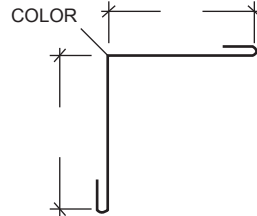

Pick Size
4" x 4" or
3" x 3"

Utility Eave

T-18

Pitch _____

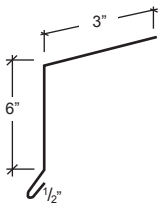

Inside Angle

T-22

Size _____

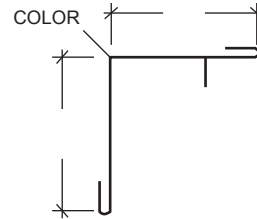

Pick Size
4" x 4" or
3" x 3"

Peak Boxes

T-19

Pitch _____

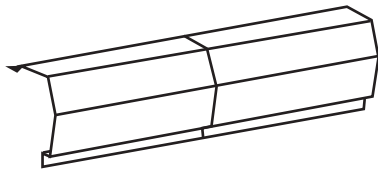

Corner Boxes

T-23

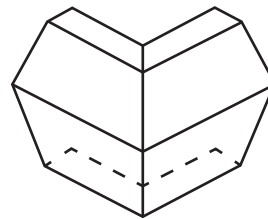

Hi - Side Eave

T-20

Pitch _____

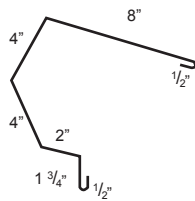

Downspout Straps

T-24

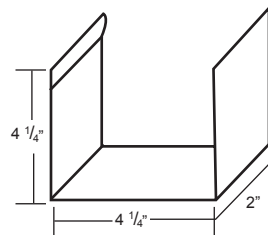

RESIDENTIAL TRIM

R-PANEL OR TUFF RIB

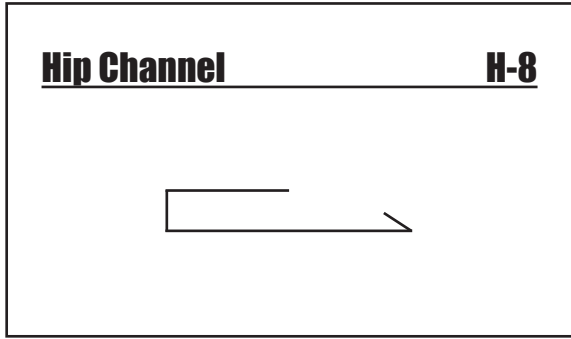
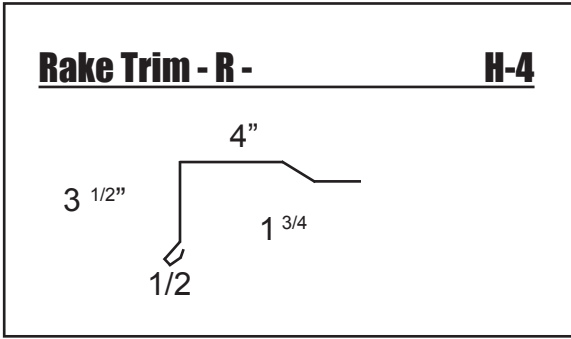
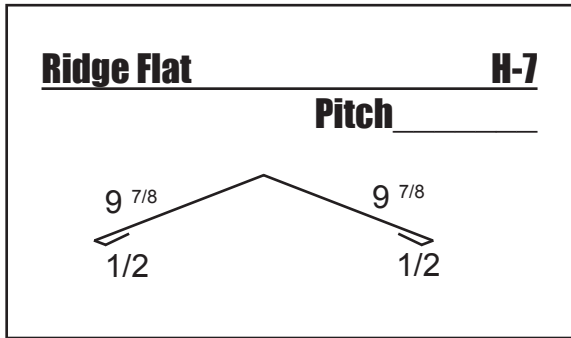
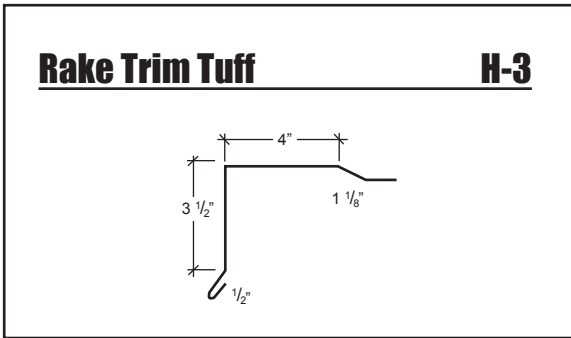
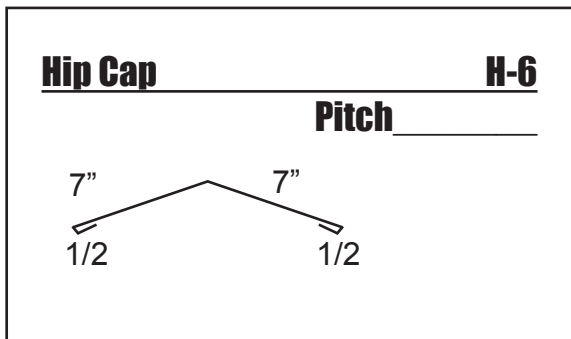
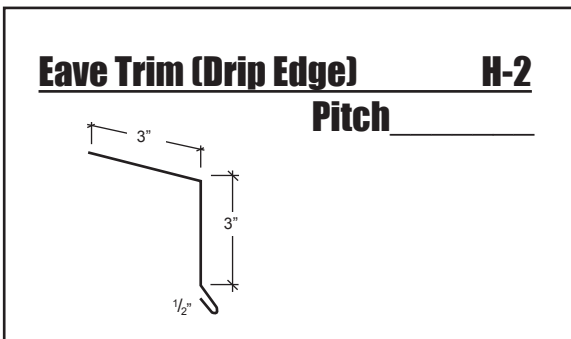
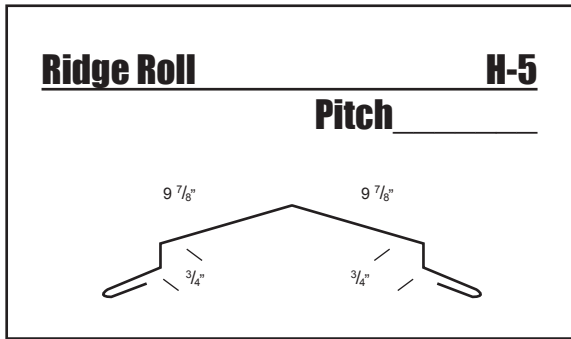
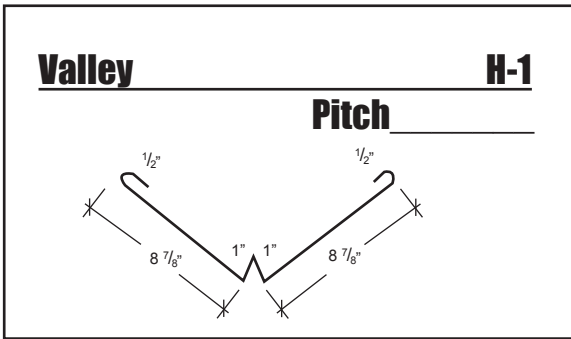

TUFF-RIB

The Tuff-Rib® Design is Unmatched In Performance Durability.
(26 GA)

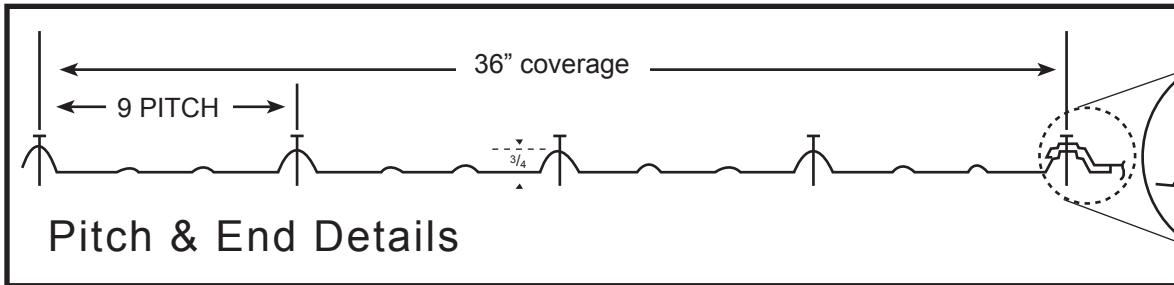

R-PANEL

A Superior Roof or Wall panel with Maximum strength.
(26 GA ONLY)

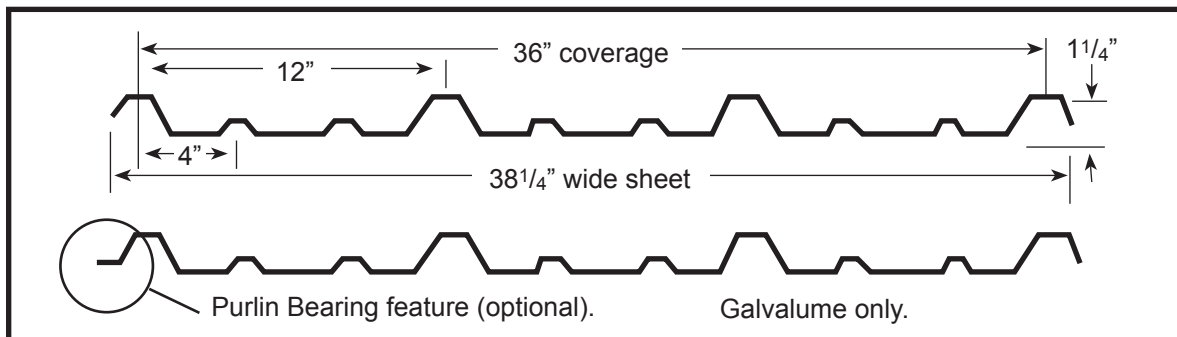

STANDARD COLORS

Galvalume
White
Lt. Stone
Tan
Ash Grey

Charcoal Grey
Rustic Red
Crimson Red
Hawaiian Blue

KoKo Brown
Burnish Slate
Fern Green
Hunter Green

ACCESSORIES

